

ULTRACRAFT Reflex **RS Turbo**

New Upgraded Screen
Precision Matched with Speed

🕒 Enhanced Amber Screen

566:1 Contrast Ratio

📏 C5 Grade Z-axis Module

Movement Error within $\pm 2\mu\text{m}$

🚀 Dynamic Motion Algorithm 3.0

33%* Increase in Print Speed

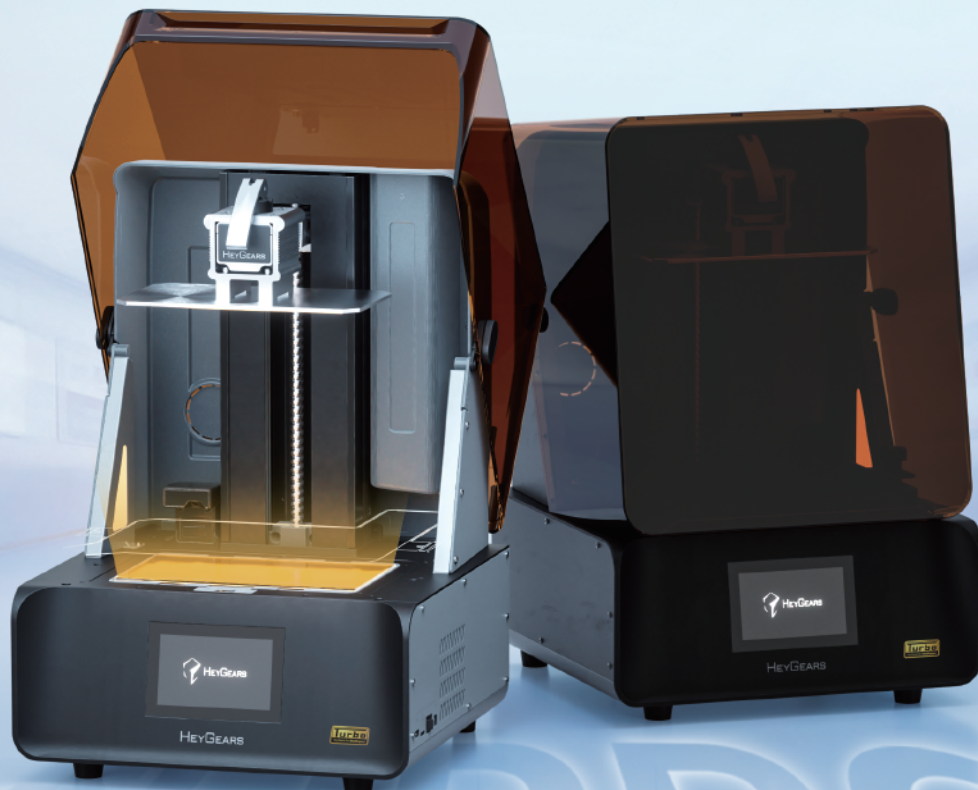

Printing Accuracy and Reliability

Optimized Amber Screen High Contrast Ratio of 566:1*

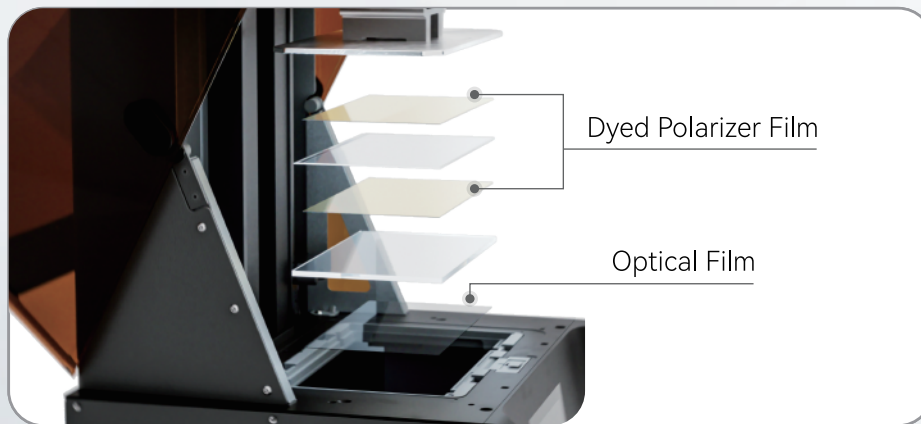

*Data sourced from HeyGears Lab.

Precise Prints with Sharper Details

The dyed polarizer film layer utilizes dye macromolecules, allowing for better control of light transmittance. This reduces overexposure or underexposure, ensuring sharp details for 3D prints.

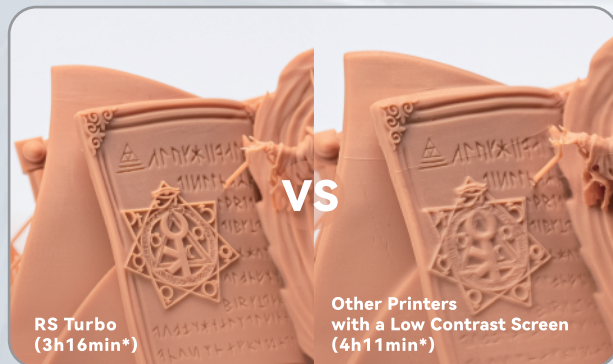

*Data sourced from HeyGears Lab, utilizing PARP10 Orange Clay Resin for printing. Printing results may vary per model.

Smooth & Defect-Free Surfaces

The Amber Screen features an optical film layer engineered to transmit light at 90° optimal angles, reducing stray light reaching the curing layer and ensuring residue-free surface smoothness.



*Data sourced from HeyGears Lab, utilizing PAP10 Precise Detail Resin for printing. Printing results may vary per model.

Over 1 Million* Layers 3D Printing Capability

- ◆ The dyed polarizer film employs dye macromolecules with excellent UV resistance and heat stability. This minimizes degradation, leading to reduced contrast decay and improved light projection reliability, ultimately extending the screen's lifespan.

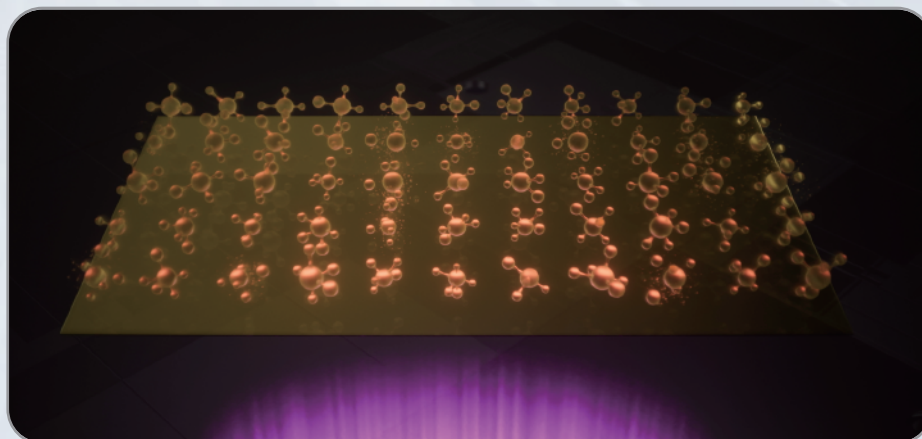

*Estimates based on PAWW20 water-washable resin - results of other resins may vary.
**Molecular structure for illustration purposes only.

Full-Field Precision Screen

- ◆ To achieve printing high accuracy and reliability, we partition the screen into 60 zones and calibrate it with a full-screen tool, ensuring light intensity variation remains within $\pm 3\%$ * for a printing tolerance of ≤ 0.05 mm.

LCD Screen Light Intensity Visualization

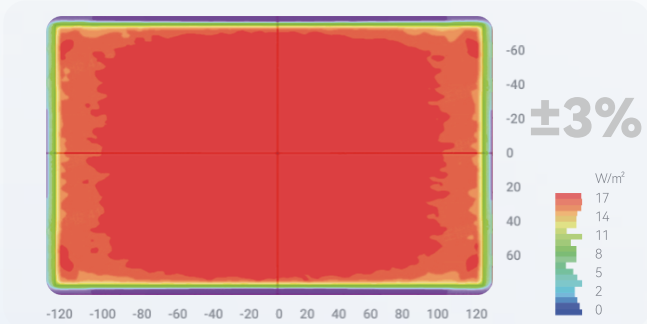

Test Model Results

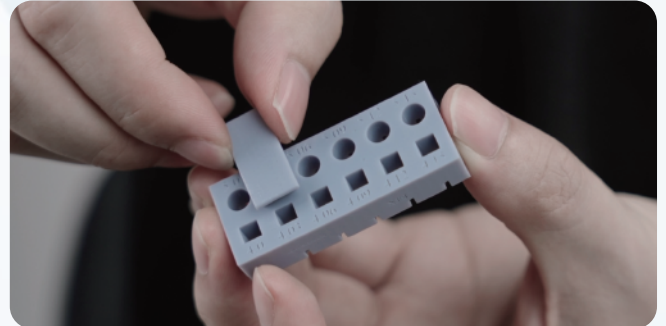

*Data sourced from HeyGears Lab

Reliable C5 Grade Z-axis Module

- ◆ High repeat positioning accuracy ensures layer positioning errors are no more than $2 \mu m$ *. Tested with a 50 kg load across ten thousand runs.

RS Turbo Z-axis Repositioning Variation

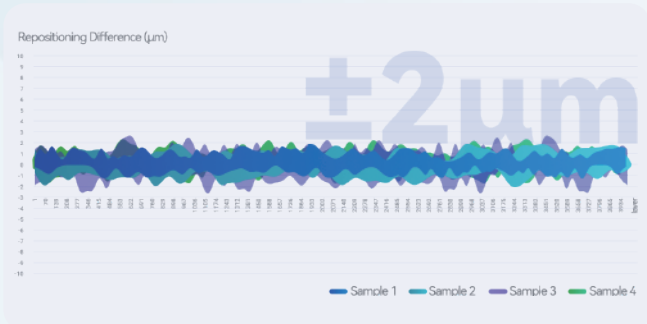

Test Model Results



*Data sourced from HeyGears Lab, 96% of errors within $1 \mu m$, 99.9% of errors within $2 \mu m$.

Adaptive Z-axis Compensation

- ◆ The process package allows the RS Turbo printer to adjust the Z-axis compensation adaptively for each resin, to support up to 180 combinations of different angles, hole sizes, and edge types. This approach minimizes deformation and resin buildup on support surfaces.

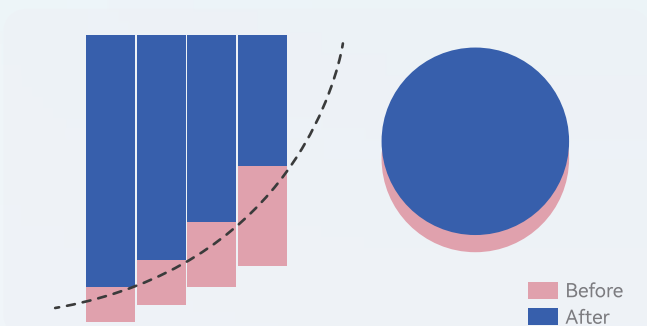

Test Model Results

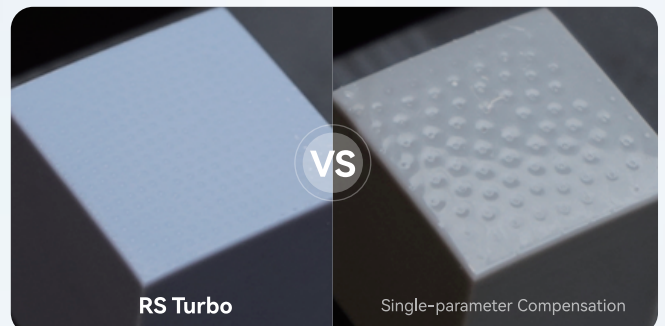

*Data sourced from HeyGears Lab

02

Injection-molded Precision with 2 Hour Speed*

*Data from HeyGears Lab, using a layer thickness of 50 μm and model height under 7 cm; printing results may vary per model.

Built for High Speed: 4.5 s/layer Average Printing Speed*

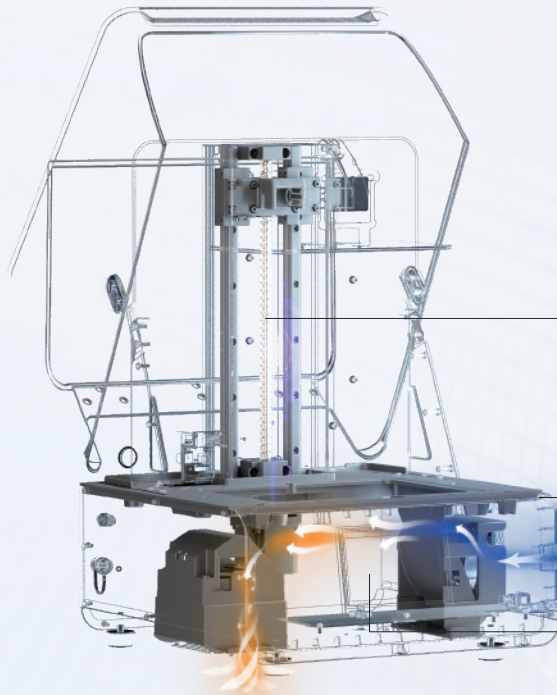

 **C5 Z-axis Module**

 **High-rigidity Printer Frame****

 **Dedicated Screen Cooler*****

*Data sourced from HeyGears Lab. With high-speed water-washable resin PAWW10, the average printing speed for lattice models reaches 4.5 s/layer.

**Printer frame flex within $\pm 2 \mu\text{m}$.

***Cools screen temperature by up to 10°C during printing.

Dynamic Motion Algorithm 3.0

33% Increase in Print Speed*

This algorithm assesses the printing difficulty for each layer based on multiple factors, including cross-sections, parts spacing, and quantity. It then directs which parameter set to use, from a group of 18 adapted parameter options of motion control. This ensures printing quality while enhancing overall printing speed.

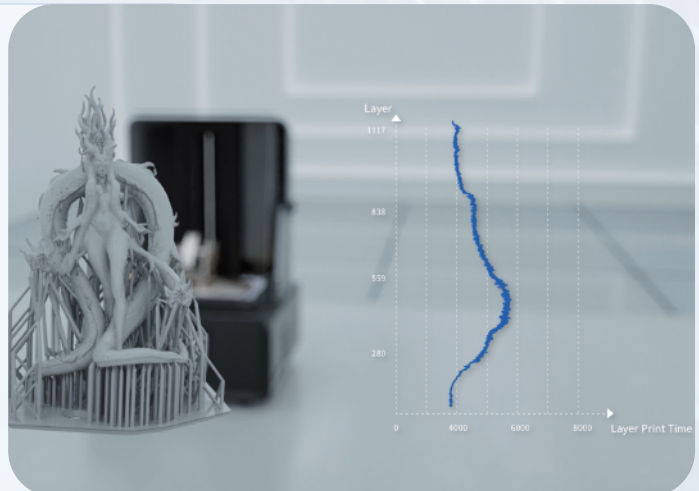

*Data sourced from HeyGears Lab, utilizing PAWW10 water-washable resin, compared to conventional motion control 3D printing. The exact speed increase may vary based on model.

**Model created by Great Grimoire.

03

Get Printing in Minutes

Ready to Print within **10 minutes***

Learning Time Less than **60 minutes**



*Data sourced from HeyGears Lab

Automated Printing Assistance

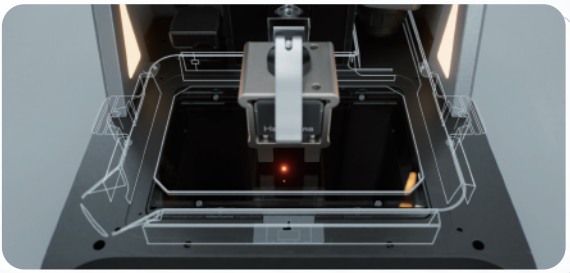

[🔊] High-sensitivity Residue Detection

Force sensors with a sensitivity of 0.1 N can detect resin residue as small as 0.2 mm and can auto-stop upon detection or print failure.

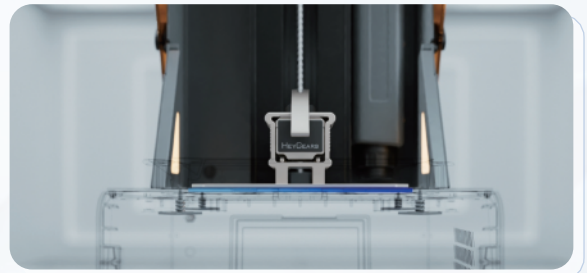

[📐] Floating Screen Auto Leveling

A floating screen system with a deviation of 0.15° eliminates gaps of up to 240 μm for automatic leveling.

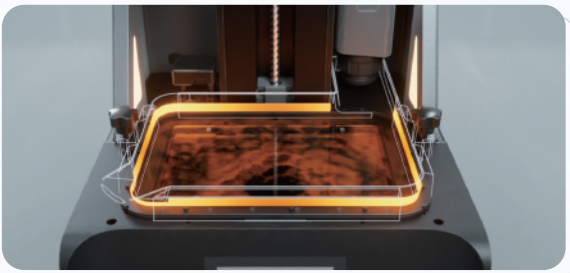

[🔥] Automatic Resin Heating

The optional RS heated resin tank uses an integrated heater for higher efficiency. It can elevate resin temperature from 50 °F (10 °C) to an optimal 73 °F (22 °C) in 20 minutes, auto heating maintains this temperature throughout the printing process for optimal results.



[🔄] Automatic Resin Refill

Automatic resin refill before and during printing, no supervision required.

Versatile Material System

Effortless Production of Refined & Durable Products

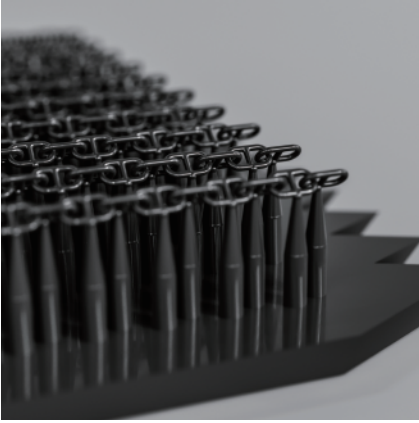

Excellent Fine Structure Printability

Smallest Convex Detail of 0.06 mm

UltraPrint-Production PAF10
High-precision Application Resin

*Test data for PAF10 Black color resin.



Impressively Bendable

46% Elongation at Break

UltraPrint-Production PAF10
Flexible Production Resin
(PVC-like)



Suitable for Drilling and Tapping

86 MPa Flexural Modulus

UltraPrint-Modeling PAU11
General Purpose Modeling Resin
(ABS-like)

*Data sourced from HeyGears Lab.

A Complete Production System



05

Reflex R5 Turbo Specifications

3D Printing Technology	LCD (MSLA)
Screen	10.3-inch 8K Amber Screen
Build Volume	222*122*228 mm
XY Native Pixel	29.7 μm
Accuracy	$\pm 15 \mu\text{m}$
Layer Thickness	30-100 μm
Optical Wavelength	405 nm
Size	380*360*584 mm
Weight	20 kg
Rated Power	180 W
Voltage	100-240 V~50/60 Hz
Connectivity	USB/WIFI
Language	English, Simplified Chinese, Japanese

REFLEX
BO

HeyGears was founded in 2015 as an innovation-driven company, devoted to providing digital manufacturing solutions in various industries. The company bases its core competencies in 3D printing, software development, materials, and big-data handling. We have a global presence with teams across North America, Latin America, Europe, Middle East, and Asia Pacific.

HeyGears believes in a product development process rooted deeply into vertical applications, and our vision goes beyond just 3D printing technology. We strive to create vertically integrated solutions through the solid establishment of hardware, software, material, and service platforms, delivering our goal to bring advanced technology into daily life.

HEYGEARS

 www.heygears.com

 sales@heygears.com

 +1 (318) 353-4295 (Global) / +1 (949) 418-9418 (USA) / +49 211 93598403 (Europe)

 USA: 17931 Sky Park Circle, Suite E, Irvine, CA, 92614

CHN: Block B2, 501, 601, Enterprise Accelerator, Kaifa District, Guangzhou, Guangdong, China



Follow us @HeyGears